





swiss bed concept



OAKLINE

EICHE MASSIV | CHÊNE MASSIF | SOLID OAK

Achten Sie auf FSC®-zertifizierte Produkte | Soyez attentifs aux produits certifiés FSC® | Look for FSC®-certified products

Bettrahmen | Cadre de lit | Bedframe

Modul 18

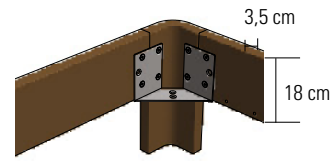

Breiten | Largeurs | Widths:
90, 100, 120, 140, 160, 180, 200 cm

Längen | Longueurs | Lengths:
190, 200, 210, 220 cm

Einlegetiefe | Hauteur encastrable | Insertion depth:
18 cm

Traversen | Traverses | Bars

Wir empfehlen grundsätzlich den Einsatz von Crosstraver (Quertraverse) oder Midtraver (Längstraverse).

Nous recommandons en général l'utilisation de Crosstraver (traverse transversale) ou Midtraver (traverse centrale).

We recommend basically the insertion of Crosstraver (central cross bar) or Midtraver (central bar).



Crosstraver

Quertraverse | Traverse transversale | Central cross bar

Für alle Bettbreiten | Pour toutes les largeurs de lit | For all bed widths



Crosstraver-Twin

Quertraversen | Traverses transversales | Cross bars

Für alle Bettbreiten | Pour toutes les largeurs de lit | For all bed widths



Midtraver

Längstraverse | Traverse centrale | Central bar

Für Betten ab Breite 140 cm mit 2 Lattenrosten oder Motorrahmen-einbau | Pour les lits à partir de 140 cm de largeur avec 2 sommiers ou l'installation d'un cadre motorisé | For beds from 140 cm width with 2 slats or motor frame installation



Crosstraver-XXL

Quertraversen | Traverses transversales | Cross bars

Für alle Bettbreiten | Pour toutes les largeurs de lit | For all bed widths

Übersicht Kompatibilität Traversen siehe Seite 2.12 | Aperçu compatibilité traverses voir page 2.12 | Overview compatibility bars see page 2.12

Ausführungen | Exécutions | Executions

Holz | Bois | Wood



86

Eiche natur, gebürstet, geölt

Chêne naturel, brossé, huilé
Oak natural, brushed, oiled



89

Eiche graphit, gebürstet, geölt

Chêne graphit, brossé, huilé
Oak graphit, brushed, oiled



91

Eiche cognac, gebürstet, geölt

Chêne cognac, brossé, huilé
Oak cognac, brushed, oiled

Füsse | Pieds | Feet

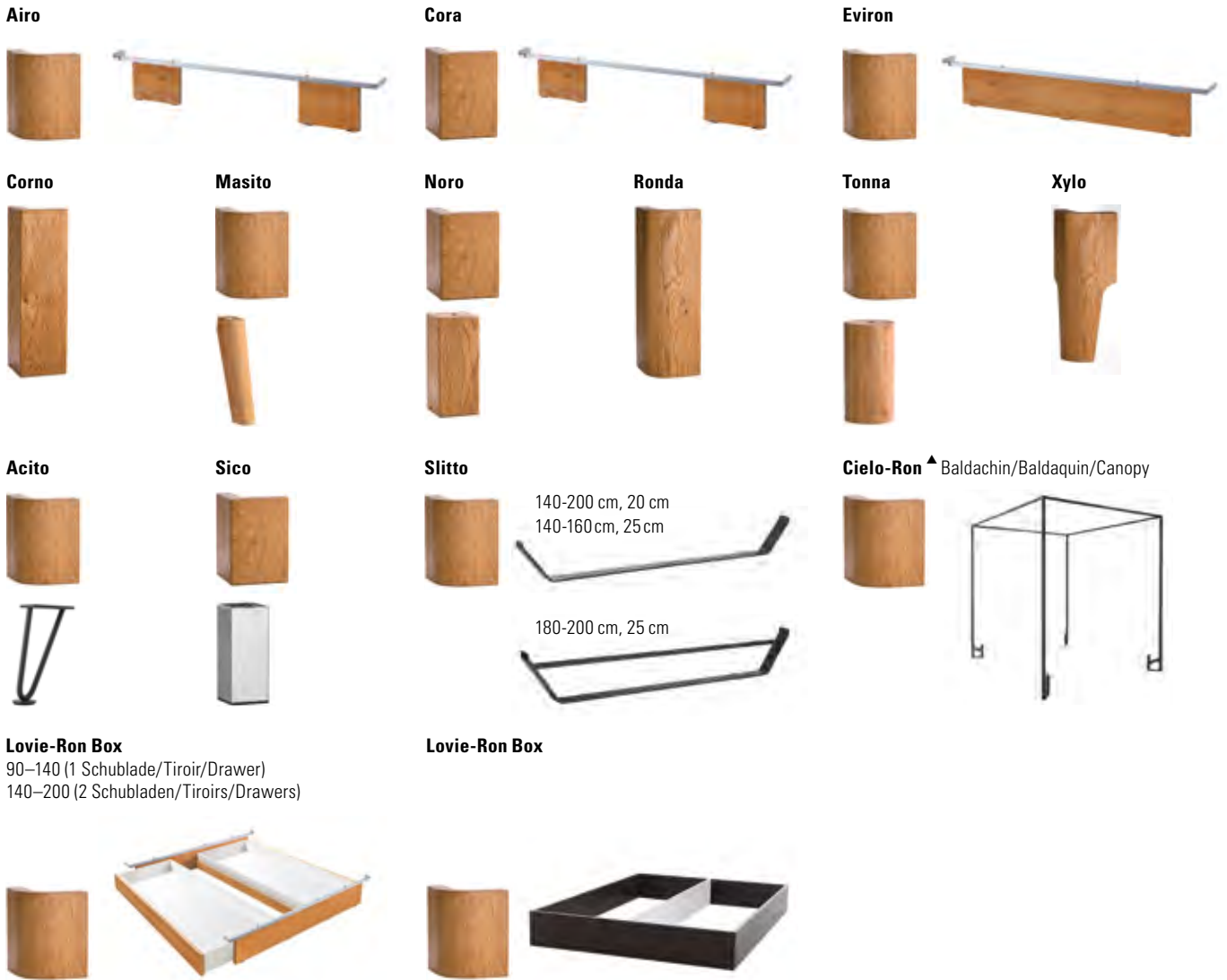

Holz | Bois | Wood

	Breiten cm Largeurs cm Widths cm	Höhen cm Hauteurs cm Heights cm			Holzfarben Couleurs bois Colours wood				
		20	25	30	10	16	86	89	91
Airo	90-200	●					●	●	●
Cora	90-200	●					●	●	●
Corno		●	●	●			●	●	●
Eviron	90-200		●		●	●	●	●	●
Lovie-Ron Box (1 Schublade/Tiroir/Drawer)	90-140		●		●	●	●	●	●
Lovie-Ron Box (2 Schubladen/Tiroirs/Drawers)	140-200		●		●	●	●	●	●
Masito		●	●				●	●	●
Noro		●	●	●			●	●	●
Practico-Ron Box*	90-200		●		●	●	●	●	●
Ronda		●	●	●			●	●	●
Tonna		●	●	●			●	●	●
Xylo		●	●	●			●	●	●

Metall | Métal | Metal

	Breiten cm Largeurs cm Widths cm	Höhen cm Hauteurs cm Heights cm			Metallfarben Couleurs métal Colours metal			
		20	25	30	10	16	42	43
Acito		●				●		
Cielo-Ron [▲]	120-200	●			●	●		
Sico		●	●	●				●
Slitto	140-200	●	●		●	●	●	●

[▲] **Curty Vorhang und Vela Baldachin-Tuch siehe Register 2, Seite 2.7** | Curty rideau et Vela tissu de baldaquin voir registre 2, page 2.7 | Curty curtain and Vela canopy cloth see index 2, page 2.7

Eckfüsse/Eckteile + Füße (inkl. Beschläge) | Pieds d'angles/Pièces d'angles + Pieds (Visserie incl.) | Corner feet, Corner pieces + Feet (Fittings included)

*weiss/anthrazit = MDF

*blanc/anthracite = MDF

*white/anthracite = MDF

Metall | Métal | Metal



10 Weiss | Blanc | White

16 Anthracit

42 Alu

43 Inox

Bettkasten mit Holzkufe | Tiroirs de lit avec patins en bois | Bed drawers with wooden vat



Lovie-Ron Box + Covero
90-140 cm 1 Schublade | 1 Tiroir | 1 Drawer

Stauraum | Compartment de rangement | Storage space:
134 × 61 × 16 cm

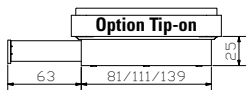
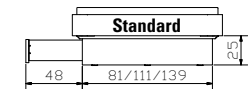

Standard: gedämpfter Selbsteinzug Blumotion von BLUM
Option: Tip-on-Öffnung mit Vollauszug von BLUM

Lovie-Ron Box + Saceto
140-200 cm 2 Schubladen | 2 Tiroirs | 2 Drawers

Stauraum | Compartment de rangement | Storage space:
2 × 134 × 61 × 16 cm

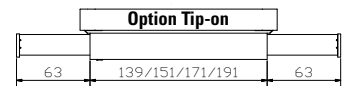
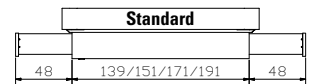

Standard: système d'amortissement Blumotion de BLUM
Option: ouverture Tip-on avec sortie totale de BLUM

Standard: soft closing runner Blumotion of BLUM
Option: opening Tip-on with full extension of BLUM

Roll-Box 20/25



Bettkasten in weiss oder anthrazit (Boden weiss)

Voraussetzung
Bettfusshöhe von mindestens 20 cm erforderlich

Optionen
Deckel Covero in weiss, Stoffabdeckung Saceto in Polyester grau.

Roll-Box 20/25 + Covero



Tiroir de lit en blanc ou anthracite (fond blanc)

Condition préalable
Une hauteur de pieds de lit d'au moins 20 cm est nécessaire

Options
Couvercle Covero en blanc, tissu de protection Saceto en polyester gris.

Roll-Box 20/25 + Saceto



Bed drawer in white or anthracite (bottom white)

Condition
Feet of bed need a minimum height of 20 cm

Options
Covero in white, tissue of protection Saceto in polyester grey.



Roll-Box 20

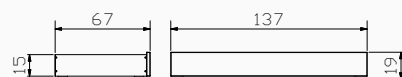

Roll-Box 25

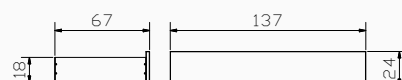

Stauraum | Espace de rangement | Storage space

Roll-Box 20	=	134 × 61 × 13 cm
Roll-Box 25	=	134 × 61 × 16 cm

Bettkasten | Coffres à literie | Bedding boxes

Practico-Ron Box + Modul 18 + Ultrafree-Lift KF



Practico-Ron Box + Modul 18 + Econom-move



Stauraum | Compartiment de rangement | Storage space

90 × 200/210/220	=	81 × 190/200/210 × 24 cm
100 × 200/210/220	=	91 × 190/200/210 × 24 cm
120 × 200/210/220	=	111 × 190/200/210 × 24 cm
140 × 200/210/220	=	131 × 190/200/210 × 24 cm
160 × 200/210/220	=	74 × 190/200/210 × 24 (2 x) cm
180 × 200/210/220	=	84 × 190/200/210 × 24 (2 x) cm
200 × 200/210/220	=	94 × 190/200/210 × 24 (2 x) cm

Ultrafree-Lift KF

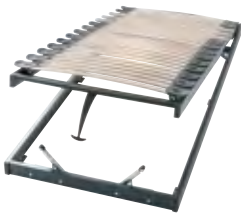

Econom-move

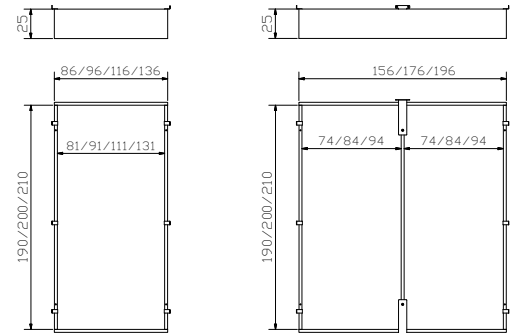

Box = inkl. Boden, Anwendung siehe Seiten 10.14–10.15
zu Practico-Ron Box:
 Lattenrost **Ultrafree-Lift KF**
 Kopf-/Fussverstellung
 Rahmenholme Höhe 7 cm und 28 Federleisten
 aus Buchenschichtholz
 Gesamthöhe 11 cm

Lattenrost **Econom-move**
 Unverstellbar
 Rahmenholme Höhe 6 cm und 28 Federleisten
 aus Buchenschichtholz
 Gesamthöhe 9 cm

inkl. Gasdruckfedern und allen Beschlägen

Details zu Ultrafree-Lift KF und Econom-move
 siehe Register 14, Seite 14.8

Box = fond inclus, utilisation voir pages 10.14–10.15
pour box Practico-Ron:
 Sommier **Ultrafree-Lift KF**
 Tête et pied réglables
 Cadre, hauteur 7 cm et 28 lattes en hêtre multiplis
 Hauteur totale 11 cm

Sommier **Econom-move**
 Non réglable
 Cadre, hauteur 6 cm et 28 lattes en hêtre multiplis
 Hauteur totale 9 cm

Pistons à gaz et toute la quincaillerie inclus

Détails pour Ultrafree-Lift KF et Econom-move
 voir registre 14, page 14.8

Box = bottom incl., handling see pages 10.14–10.15
for Practico-Ron box:
 Slats **Ultrafree-Lift KF**
 Head/footpiece adjustable
 Frame, height 7 cm and 28 slats are of beech veneer board
 Total height 11 cm

Slats **Econom-move**
 Not adjustable
 Frame, height 6 cm and 28 slats are of beech veneer board
 Total height 9 cm

Pneumatic compression spring and all fittings included

Details for Ultrafree-Lift KF and Econom-move
 see index 14, pages 14.8

Himmelbett ohne Grenzen

Lit à baldachin sans frontières | Canopy bed without borders



Betrahmen
 Cadre de lit | Bedframe

Cielo
 Baldachin | Baldaquin | Canopy

Kopfteil
 Tête de lit | Headboard



Kopfteile | Têtes de lit | Headboards

Alpa



Dimension: 140, 160, 180, 200

Soleo



Dimension: 140, 160, 180, 200

Lisio



Dimension: 90/100, 120, 140, 160, 180, 200

Varus



Dimension: 90/100, 120, 140, 160, 180, 200

gepolstert | rembourrées | upholstered

Cemoa



Dimension: 90, 100, 120, 140, 160, 180, 200 (90-120 = 1 Kissen | Coussin | Cushion)

Gewünschte Liegefläche (Länge)	= zu bestellende Bettrahmenlänge
Surface de couchage souhaitée (Longueur)	= longueur de cadre de lit à commander
Desired mattress lying area (Length)	= length of bedframe to be ordered
190	= 200
200	= 210
210	= 220

Nur montierbar mit runden Ecken. | Montage uniquement possible avec des angles ronds. | Can only be assembled with round edges. (Füsse | Pieds | Feet: Airo, Eviron, Masito, Practico-Ron Box, Ronda, Slitto, Tonna, Xylo, Cielo-Ron, Lovie-Ron Box).

Das Kopfteil Cemoa enthält in Echtleder keine Teilungsnähte.

En cuir véritable, la tête de lit Cemoa ne comporte pas de coutures de séparation. The Cemoa headboard contains no dividing seams in genuine leather.

Adapter | Adaptateur | Adapter

Bei hohen Matratzen kann mit dem Verlängerungsadapter das Kopfteil um 9 oder 13 cm erhöht werden.

La tête de lit peut être rehaussée de 9 ou 13 cm avec l'adaptateur lorsque le matelas est plus épais. With the extension adapter the headboard can be extended 9 or 13 cm if mattresses are high.

Head-Plus Metall | Métal | Metal



black

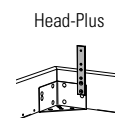
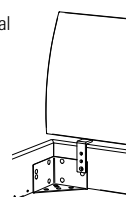

↑
+9 / +13 cm

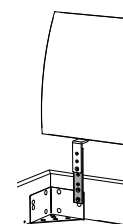

Kissen zu Kopfteilen | Coussins pour têtes de lit | Cushions for headboards

Arona + Alpa



Lumo + Alpa



Ravo + Varus



Sano + Alpa



Suny + Varus



Varo + Varus



Befestigung mit 2 Bändern (Klettverschluss)

Fixation avec 2 bandes Velcro®
Fixation with 2 ribbons (Velcro® fastener)

Kissen | Coussins | Cushions

Effektive Masse cm
Dimensions effectives cm
Effective dimensions cm

zu Kopfteilen
pour têtes de lit
for headboards

Breitenmasse cm
Dimensions de largeur cm
Widths dimensions cm

	Effektive Masse cm Dimensions effectives cm Effective dimensions cm	zu Kopfteilen pour têtes de lit for headboards		Breitenmasse cm Dimensions de largeur cm Widths dimensions cm
		Alpa	Varus	
Arona	86, 116, 136, 156, 176×3,5×25	●		140, 160, 180/200
Lumo	86, 116, 136, 156, 176×6×25	●		140, 160, 180/200
Ravo	80, 110, 130, 150, 170, 190×3,5×35	●	●	90/100, 120, 140, 160, 180, 200
Sano (2er Set set de 2 set of 2)	55×4×35	●		
Suny (2er Set set de 2 set of 2)	55×6×40	●	●	
Varo (2er Set set de 2 set of 2)	55×10×35		●	

Alle Kissen in Echtleder haben Zier- sowie Teilungsnähte. Ausnahmen: Ravo, Suny und Varo, diese Kissen haben lediglich Ziernähte. | Tous les coussins en cuir véritable ont des coutures décoratives et des coutures de séparation. A l'exception des coussins : Ravo, Suny et Varo, ces coussins ont uniquement des coutures décoratives. | All cushions in genuine leather have decorative and dividing seams. Exceptions: Ravo, Suny and Varo, these cushions only have decorative seams.

Ausführungen | Exécutions | Executions

Holz | Bois | Wood



86
Eiche natur, gebürstet, geölt
Chêne naturel, brossé, huilé
Oak natural, brushed, oiled

89
Eiche graphit, gebürstet, geölt
Chêne graphit, brossé, huilé
Oak graphit, brushed, oiled

91
Eiche cognac, gebürstet, geölt
Chêne cognac, brossé, huilé
Oak cognac, brushed, oiled

Nachttische, Kommoden | Tables de nuit, commodes | Bedside tables, chests of drawers

Caja

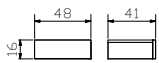

Talo

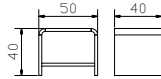

Cara

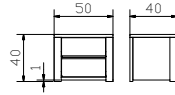

Koro

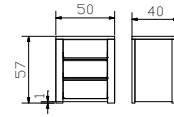

Aida

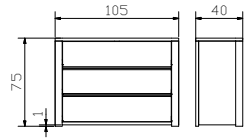

Beimöbel | Accessoires | Accessories

Bank + Kissen | Banquette + Coussin | Bench + Cushion

Sola

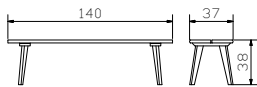

Topia

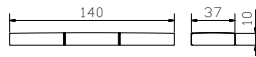

Vano

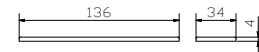

Topia, Vano

Bezugsstoffe siehe Register 1, Seiten 1.6 – 1.7

Tissus de revêtement voir registre 1, pages 1.6 – 1.7

Cover fabrics see index 1, pages 1.6 – 1.7

Herrendiener | Valet | Dressboy

Claudio alu, anthracit, iron

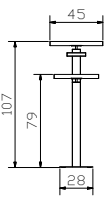
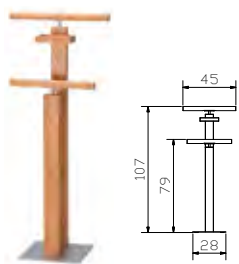

Sekretär | Secrétaire | Bureau

Aska

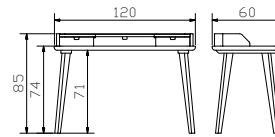

Ausführungen | Exécutions | Executions

Holz | Bois | Wood



86
Eiche natur, gebürstet, geölt
Chêne naturel, brossé, huilé
Oak natural, brushed, oiled

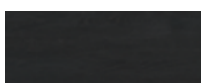

89
Eiche graphit, gebürstet, geölt
Chêne graphit, brossé, huilé
Oak graphit, brushed, oiled



91
Eiche cognac, gebürstet, geölt
Chêne cognac, brossé, huilé
Oak cognac, brushed, oiled

Metall | Métal | Metal



16
Anthracit

16 Anthracit = Stahl pulverbeschichtet | Acier thermolaqué | Steel powder-coated

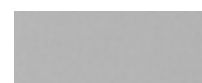

42
Alu

42 Alu = Stahl pulverbeschichtet | Acier thermolaqué | Steel powder-coated

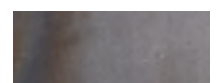

45
Iron

45 Iron = Stahl geflammt, pulverbeschichtet | Acier flammé, thermolaqué | Steel mottled, powder-coated



selezione

01

MODELLAUSWAHL

Sélection du modèle | Model selection

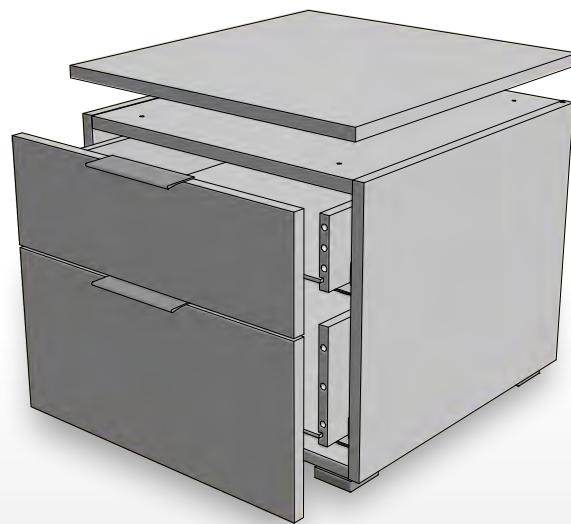

Twia



45/50/41 cm

Onia



45/50/41 cm

Owita



90/50/41 cm

Trio



45/50/55 cm

Dowe



45/50/55 cm

Dowio



90/50/55 cm

Quatro



45/50/86 cm

Unito



45/50/86 cm

Qunito



90/50/86 cm

Quatrine



90/50/86 cm

Portina



90/50/86 cm

Atrine



90/50/86 cm

Totrino



135/50/86 cm

Cassino



135/50/86 cm

Incentro



135/50/86 cm

Trequatri



135/50/86 cm

Stellen Sie sich Ihr Wunsch-Beimöbel nach Ihrem Geschmack zusammen: Der Korpus (Abb. 02), in zwei verschiedenen Farbvarianten, lässt sich zu den Front- und Top-Covern (Abb. 03) in acht Holz- und Farbausführungen kombinieren. Die Beimöbel können zerlegt oder teilmontiert bestellt werden. Bei zusammengesetzten Möbeln (z. B. Qunito, Incentro, ...) muss der Deckel noch montiert werden. Bei Kommoden mit Türen ist jeweils ein Einlegeboden vorhanden, Türöffnung nach links oder rechts möglich. Zusätzliche Böden sind erhältlich.

Composez le meuble d'appoint de vos rêves selon vos goûts : Le caisson (ill. 02), disponible en 2 variantes de couleurs, peut être combiné avec les façades et couvercles supérieurs (ill. 03) en 8 finitions de bois et de coloris. Les meubles d'appoint peuvent être commandés en kits ou assemblés. Pour les meubles assemblés (p. ex. Qunito, Incentro, ...) le couvercle doit encore être fixé. Les commodes avec portes sont équipées d'une étagère, ouverture de la porte possible à gauche ou à droite. Si besoin, des étagères supplémentaires sont disponibles.

Put together the side furniture you want according to your own taste: The body (fig. 02), in two different colour versions, can be combined with the front and top covers (fig. 03) in eight wood and colour versions. The furniture can be ordered disassembled or assembled. For assembled furniture (e.g. Qunito, Incentro, ...) the top cover must still be fitted. Chests of drawers with doors have one shelf, door opening possible to the left or right. Additional shelves are available.



Kombinationsbeispiele und techn. Informationen
Exemples et informations
Examples and informations



02

KORPUS

Caisson | Body



03

TOP/FRONT

Farben | Couleurs | Colours



04

GRIFFE

Poignées | Handles



10 Weiss | Blanc | White



16 Anthracit | Anthracite



FÜSSE

Pieds | Feet

STANDARD



OPTION

Leg 8 cm

Jone 10 cm

Cila 10 cm



alu



anthracit
used



anthracit



10 Weiss | Blanc | White



16 Anthracit | Anthracite



STANDARD



Alu

Griff zu Folienfronten

Poignée pour façades en mélaminé
Handle for foil fronts



74 Eiche bright, geölt
Chêne bright, huilé
Oak bright, oiled

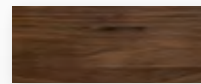

82 Nussbaum, geölt
Noyer, huilé
Walnut, oiled



76 Eiche brandy, geölt
Chêne brandy, huilé
Oak brandy, oiled



87 Wildbuche natur, geölt
Hêtre nouveau naturel, huilé
Wildbeech natural, oiled



80 Kernbuche natur, geölt
Hêtre coeur rouge
naturel, huilé
Heart beech natural, oiled

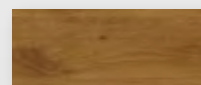

99 Wildeiche natur, geölt
Chêne nouveau naturel, huilé
Wildoak natural, oiled

STANDARD



Holzgriff zu Holzfronten

Poignée en bois pour façades en bois
Wooden handle for wooden fronts

OPTION

Rivo



Used



Anthracit

Metallgriff zu Holzfronten

Poignée en métal pour façades en bois
Metal handle for wooden fronts



The mark of
responsible forestry
FSC® C123546

Look for FSC® certified products